

The background is a smooth blue gradient, transitioning from a lighter blue at the top to a darker blue at the bottom. Several realistic water droplets of various sizes are scattered across the image, primarily concentrated in the top-left and bottom-right corners. The droplets have highlights and shadows, giving them a three-dimensional appearance.

# **Robinet de bain**

# Robinet de bain



Bélangier  
KARA 43TCP



Bélangier  
QUICK 43DT



Bélangier  
SOURCE 43TCP



Bélangier  
KARA 43TMB



Bélangier  
AXO  
43TCP



Riobel  
EVER EV16C

## Robinet de bain (suite)



Riobel  
CONIK CO02C



Riobel  
CONIK CO16C



Riobel  
CONIK CO02BK

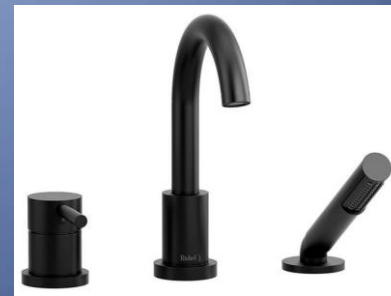

Riobel  
CONIK CO16BK

# Robinet de bain (suite)



Riobel  
EVER EV16C



Riobel  
QUADRIK QA16C

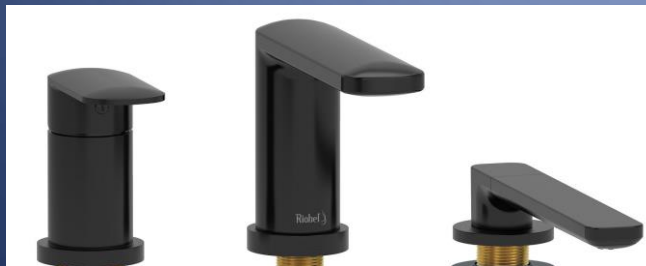

Riobel  
EVER EV16BK



Riobel  
QUADRIK QA16BK

# Robinet de bain mural

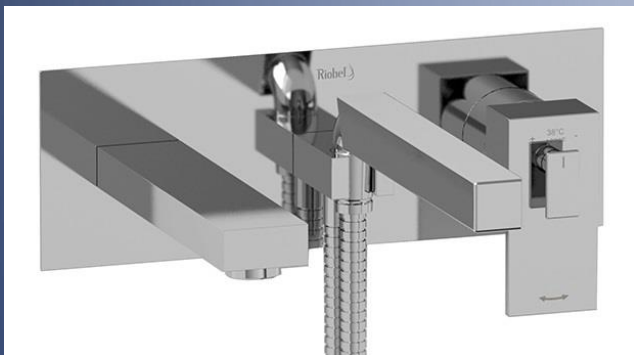

Riobel  
QUADRIK QA21C



Riobel  
QUADRIK QA21BK



Riobel  
EVER EV21C



Riobel  
EVER EV21BK

The background is a solid blue gradient. In the top-left and bottom-right corners, there are several realistic water droplets of various sizes, some overlapping, with highlights and shadows that give them a three-dimensional appearance.

# **Robinet de bain autoportant**

# Robinet de bain autoportant

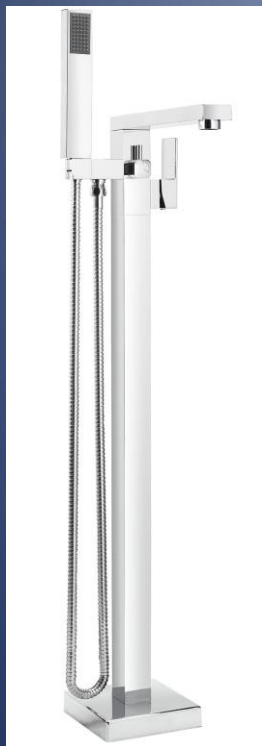

Bélanger  
AXO 45CP



Bélanger  
SOURCE 45CP

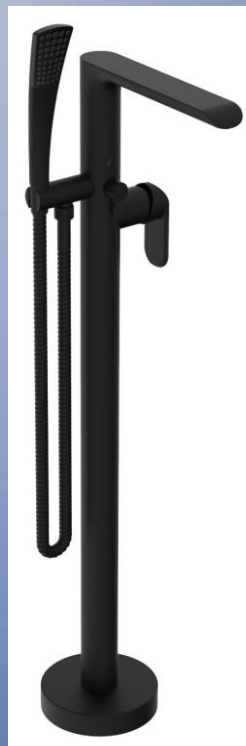

Bélanger  
KARA 45CP

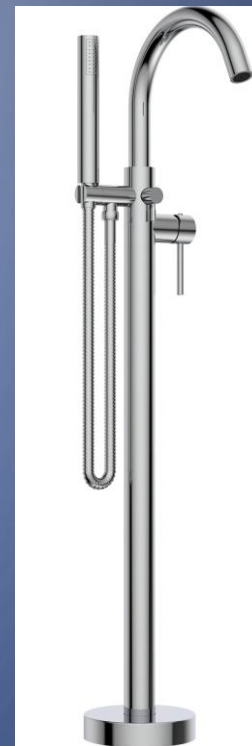

Bélanger  
KARA 45MB

# Robinet de bain autoportant

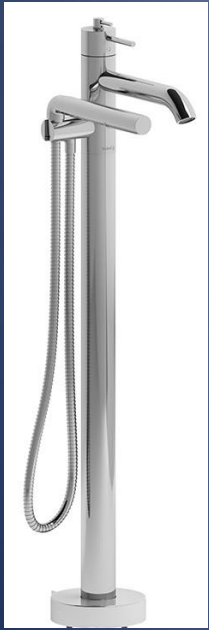

Riobel  
CONIK  
CO39C



Riobel  
CONIK  
CO39BK

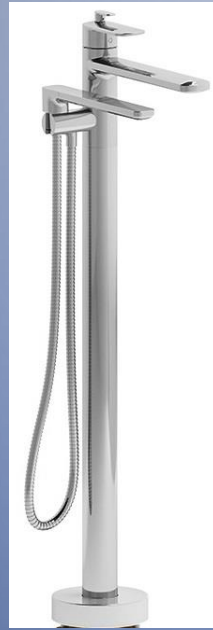

Riobel  
EVER  
EV39C

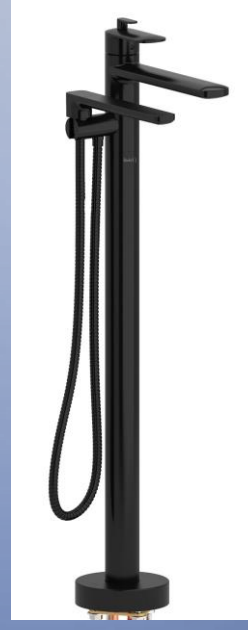

Riobel  
EVER  
EV39BK

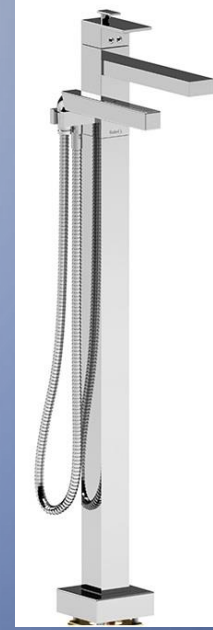

Riobel  
QUADRIK  
QA39C

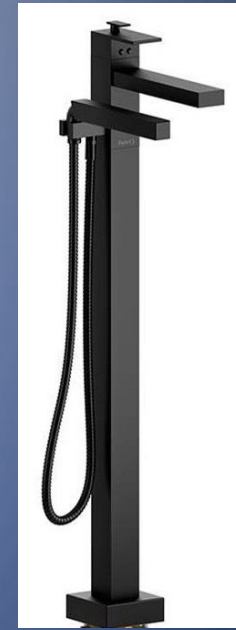

Riobel  
QUADRIK  
QA39BK